











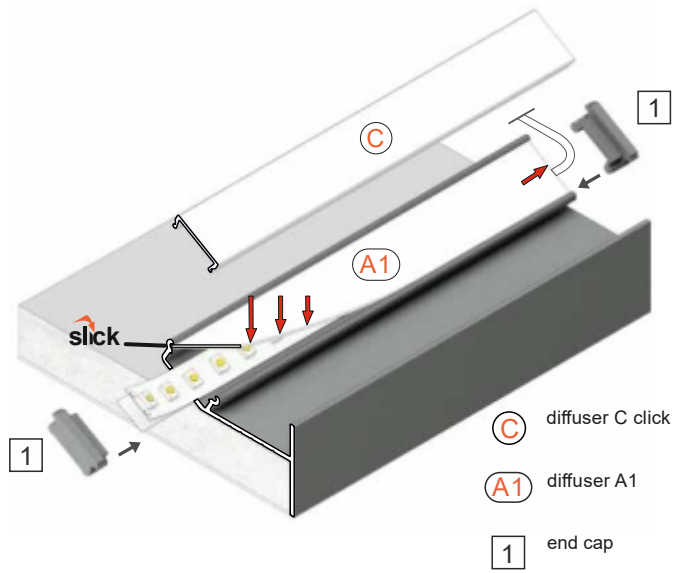
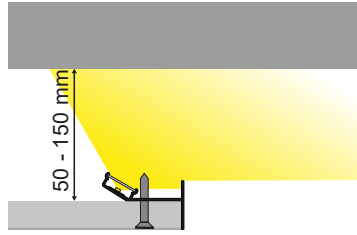
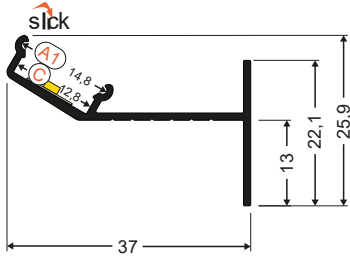

AV8290XIAA - AV8291XIAA

-  max 12 mm
-  plaster-in
-  architectural



Recommended distance of the profile from the illuminated surface - when preparing designs, take into account the parameters of the LED source used, the desired lighting effect and other lighting conditions in the room.

-  scissors
-  drill
-  hacksaw
-  pliers
-  solder
-  soldering iron
-  screwdriver
-  spatula
-  painting roller

