

AV7933XIAA C



max 10 mm



recessed



furniture

1 DIMENSIONS

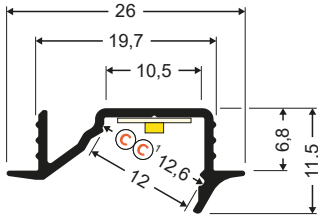

2 MOUNTING

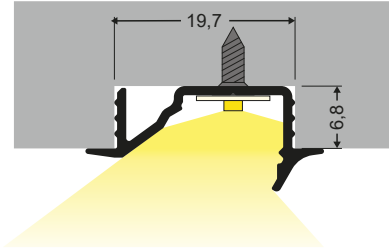

3 COMPONENTS

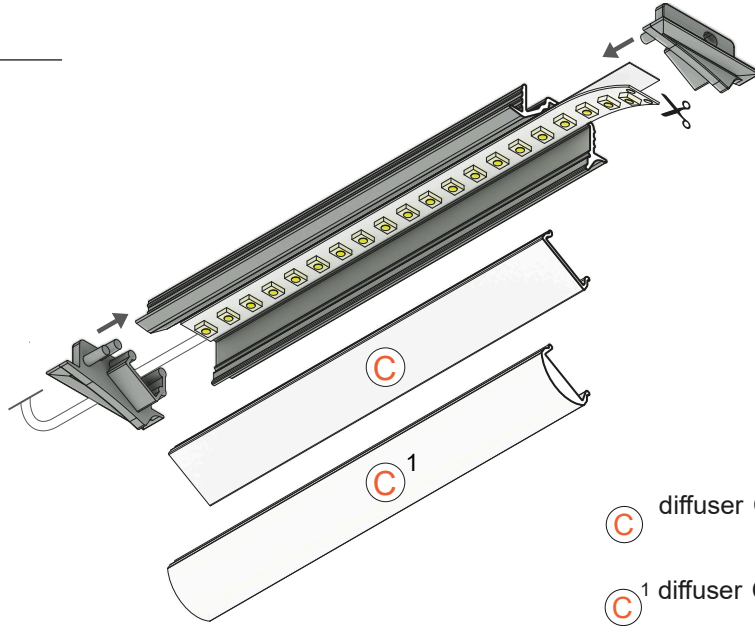

C diffuser C click

C¹ diffuser C click lens gen2



saw



pliers



solder



soldering iron



screwdriver



glue



drill

LENGTHS

4

luminaire 11 mm longer than LED profile

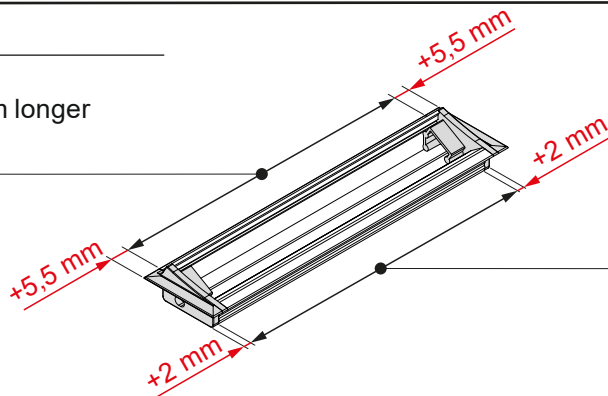

mounting hole 4 mm longer than LED profile

5.1

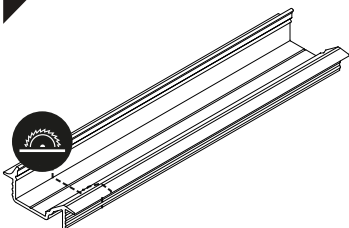

5.2

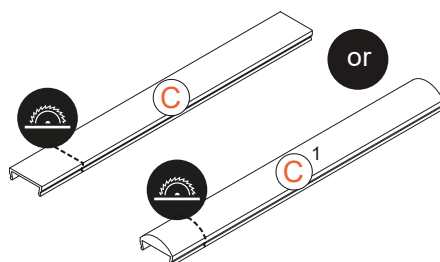

Note!

Due to the thermal expansion of the material we recommend cutting the diffuser at least 1 mm shorter per metre. Depending on various factors (e.g. power of source, room temperature).

DIMENSIONS OF THE SPACETO INSTALL LED SOURCE

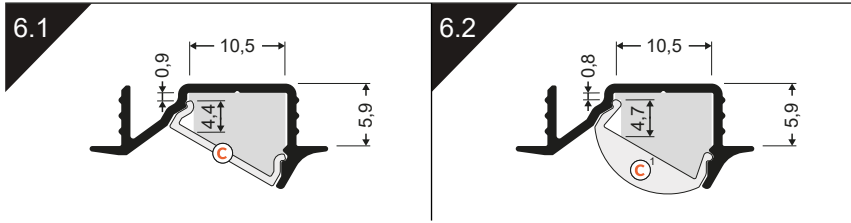

MOUNTING OF THE LED SOURCE

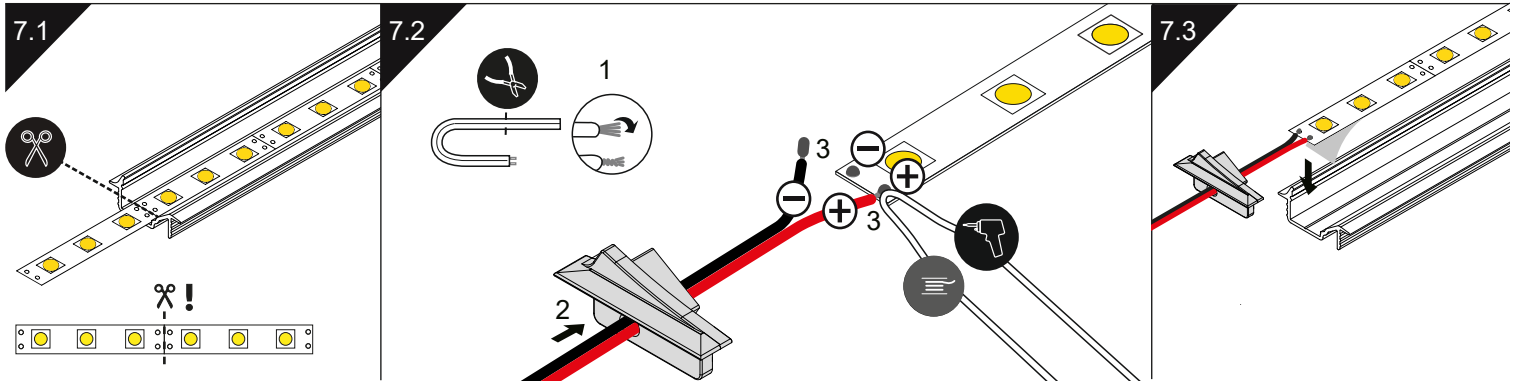

MOUNTING OF THE DIFFUSERS

MOUNTING OF THE END CAPS

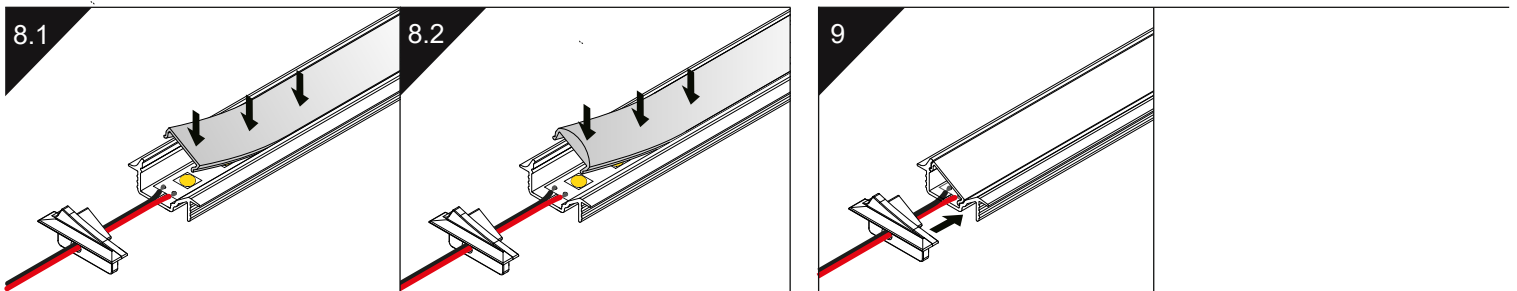

ASSEMBLY OF THE PROFILES

ASSEMBLY OF THE POWER SUPPLY

