

FLEX WALLWASHER 3D 2323 IP67 1MT

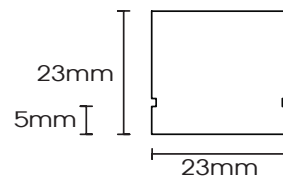

CODICE	PARAMETRI BASE				PARAMETRI FOTOMETRICI			
	Misure	LED/mt	Input Volt	Watt	CRI	Colore Luce	Lumen nominali	IP
AV5990WIAA	1000x23x23 mm	24/mt	24VDC	18W/mt	≥80	2700K	1700LM/mt	IP67
AV5989NIAA	1000x23x23 mm	24/mt	24VDC	18W/mt	≥80	4000K	1700LM/mt	IP67
AV5988CIAA	1000x23x23 mm	24/mt	24VDC	18W/mt	≥80	6500K	1700LM/mt	IP67

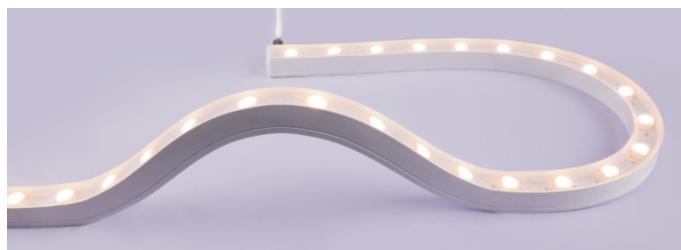
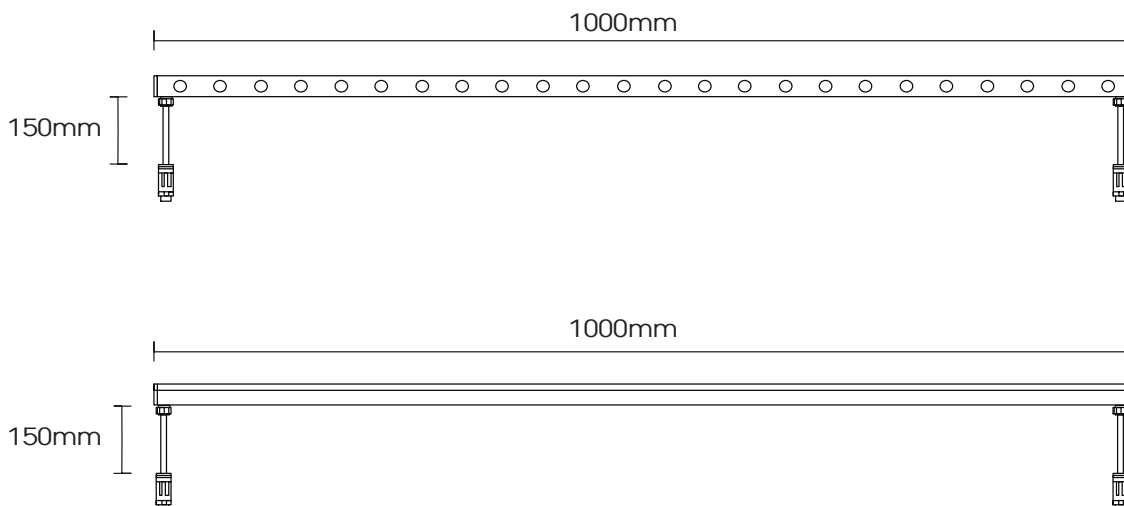

** Tipologia cavo: 2x0,75mm² - 2x18AWG wire. + Connettore con innesto IP67

FLESSIONE SU TUTTI I LATI:

Flessione laterale

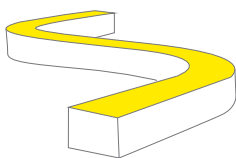

Flessione verticale

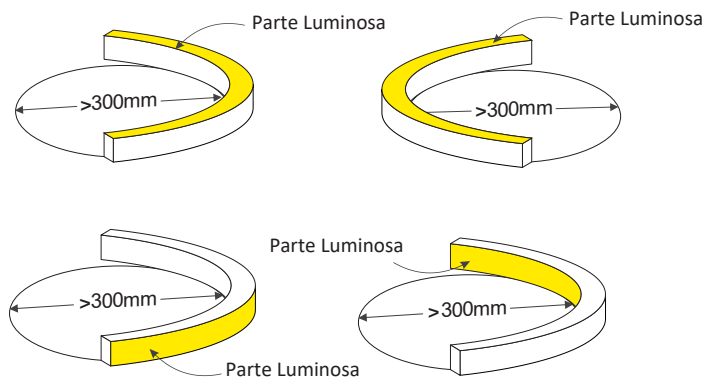
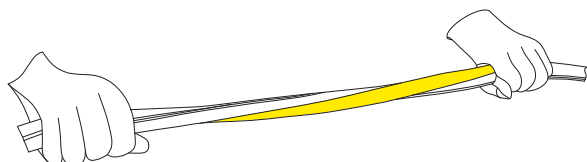
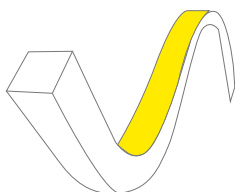

Max. Angolo di torsione è 360° per 1000mm.

FLEX WALLWASHER 3D 2323 IP67 1MT

ACCESSORI:

Profilo in alluminio da 1MT
Cod. AV5991XIAA

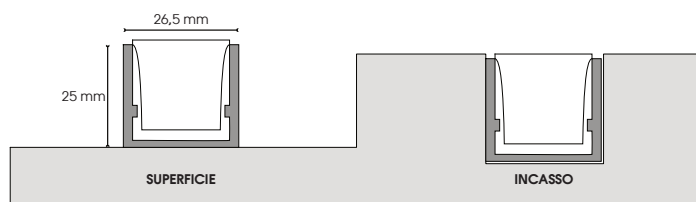
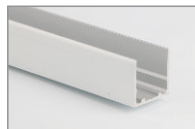
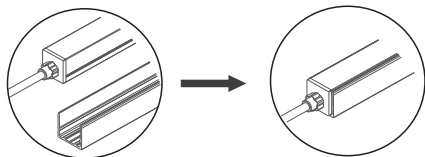

Profilo in alluminio flessibile da 10MT
Cod. AV5992XIAA

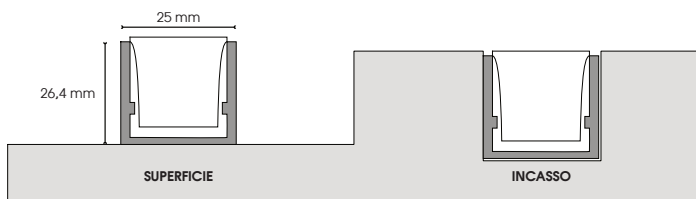
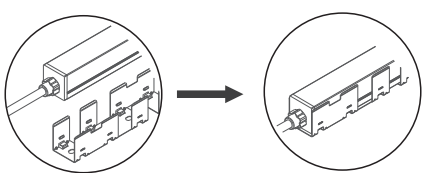

Kit 2 ganci inox
Cod. AV5993XIAA

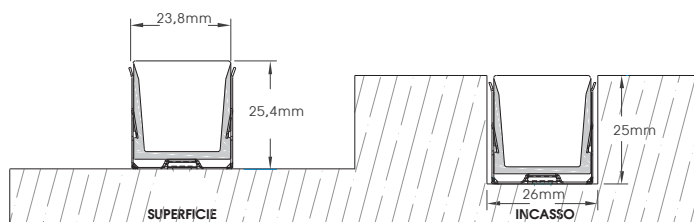
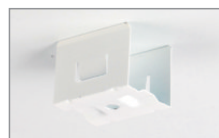
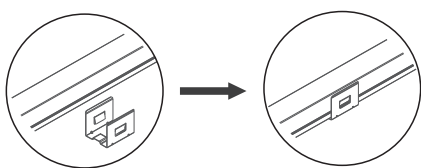

Kit 2 ganci in plastica trasparente
Cod. AV5994XIAA

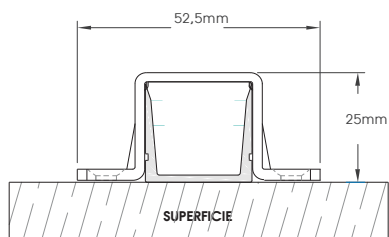
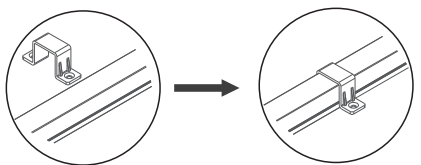

Kit 2 staffe orientabili 45° e 90°.
Cod. AV5995XIAA

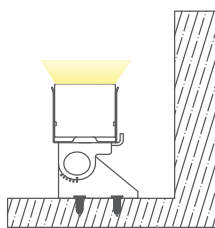
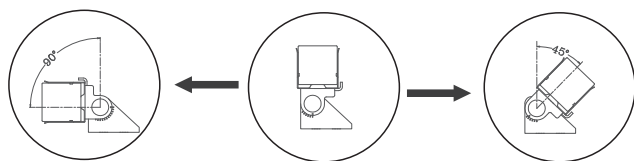

A TERRA

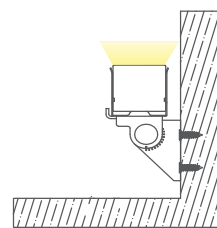

A PARETE

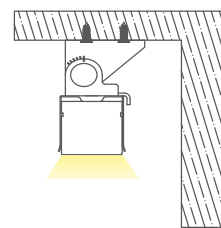

A SOFFITTO

FLEX WALLWASHER 3D 2323 IP67 1MT

FOTOMETRIE:

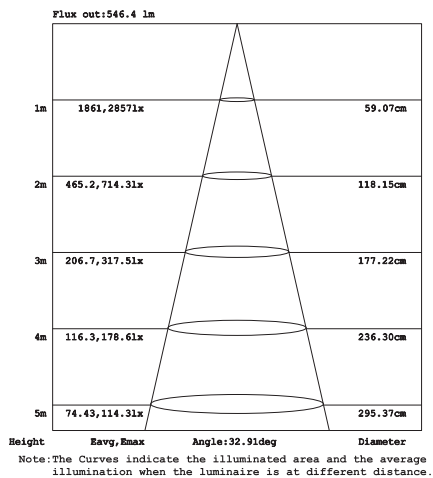
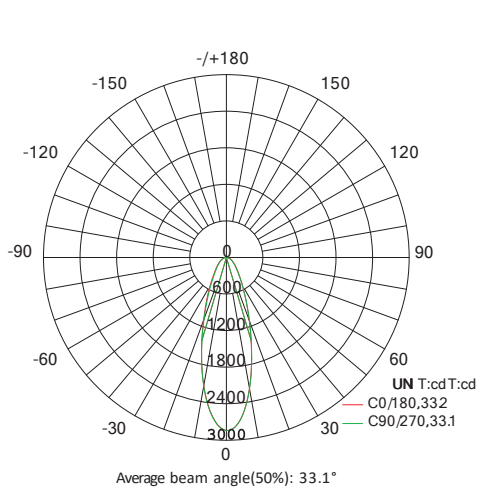

(4000K, 18W, CRI>80, 30°)

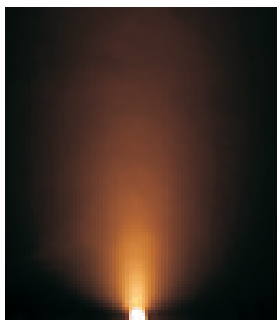

30° Side View

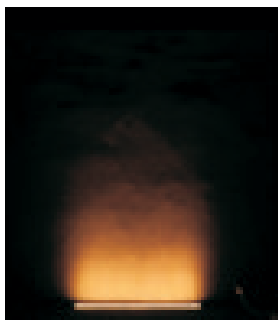

30° Front View
 Distance to the wall is 50mm
 Graze height on the wall is 1500mm



30° Front View
 Distance to the wall is 100mm
 Graze height on the wall is 2000mm



30° Front View
 Distance to the wall is 200mm
 Graze height on the wall is 3000mm



30° Front View
 Distance to the wall is 300mm
 Graze height on the wall is 3800mm

DIAGRAMMA CONNESSIONI:

