

AV5866XIAA

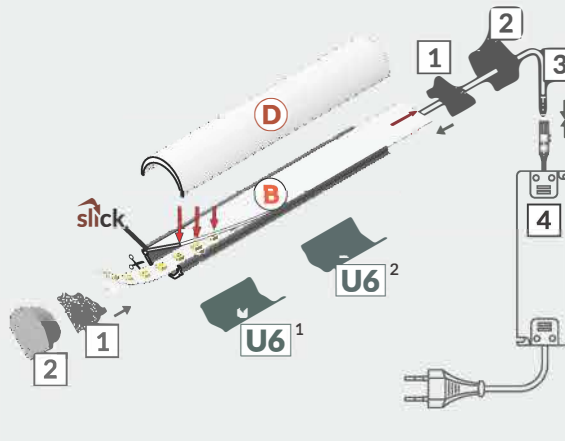

- B** B slide cover
- D** D click cover
- U6¹** U6 mounting plate
- U6²** cone U6 mounting plate
- 1** ending
- 2** D ending
- 3** power supply cable
- 4** LED power supply

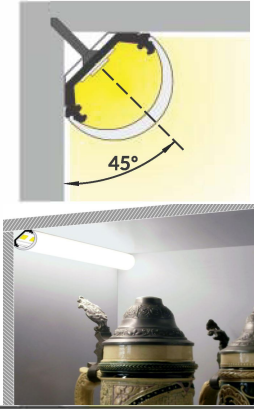
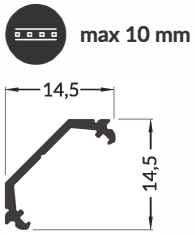
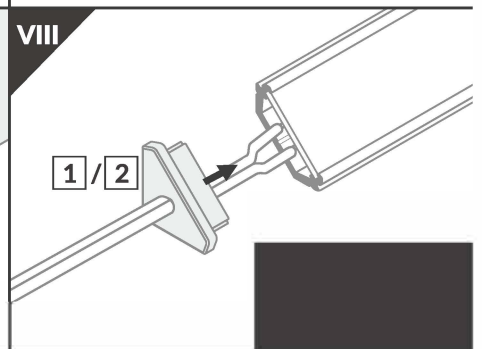
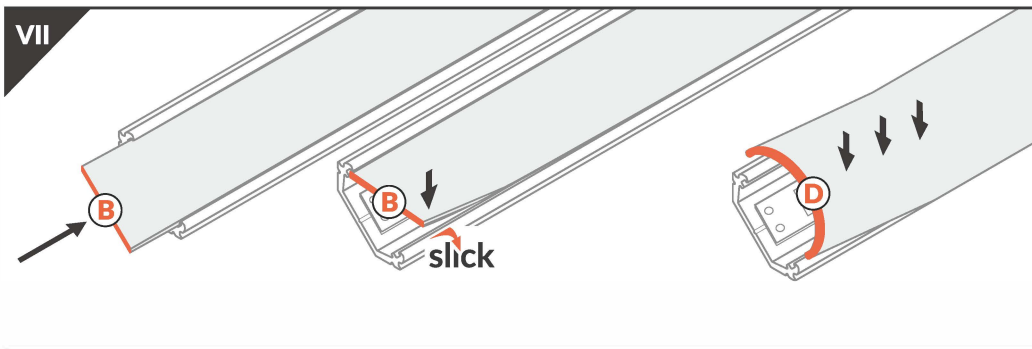
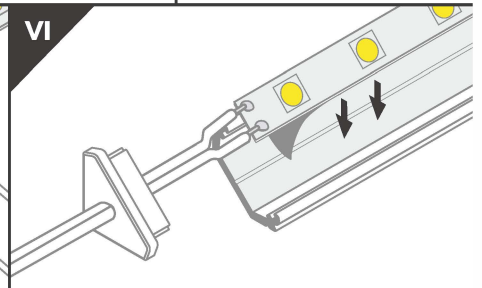
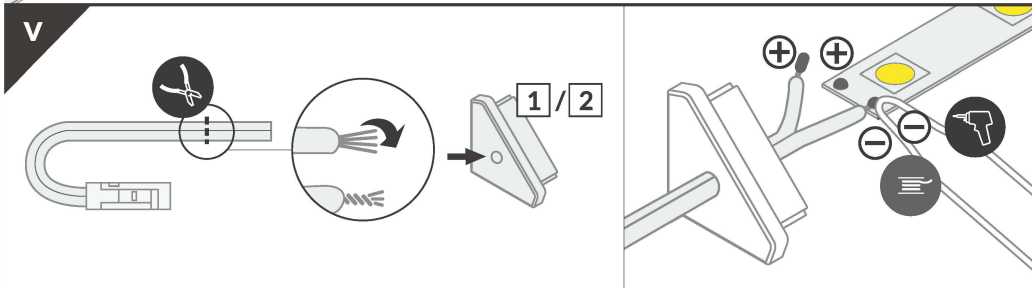
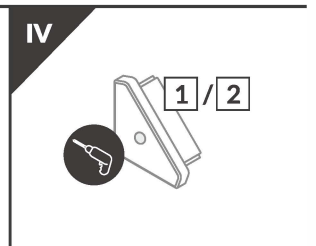
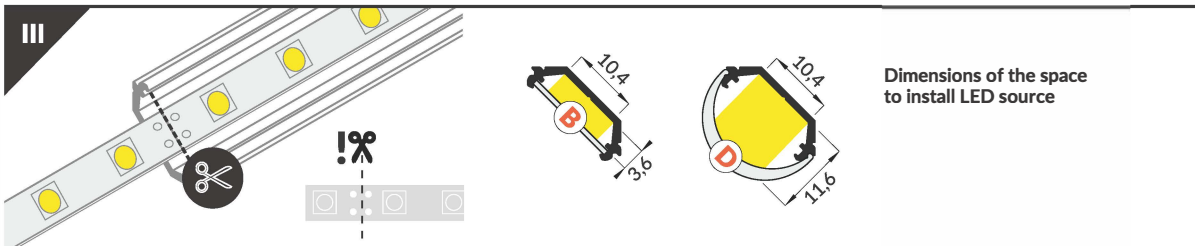
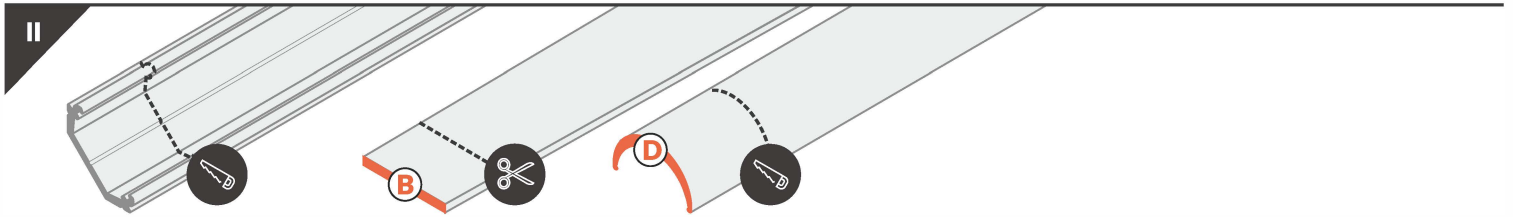
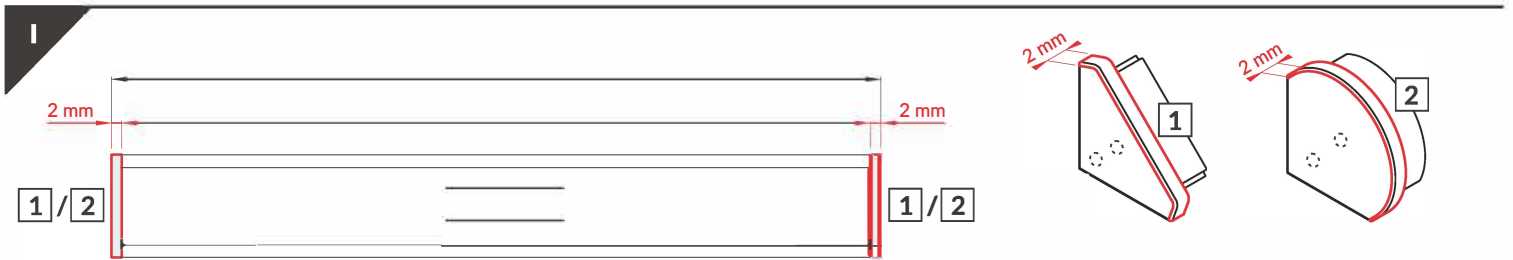
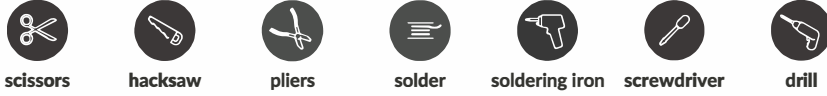

IX MOUNTING

U6 mounting plate



cone U6 mounting plate

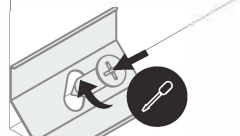

U6

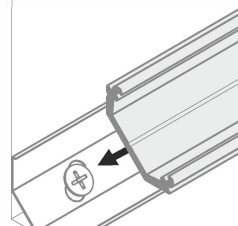

Other mounting possibilities: with mounting glue or with screws

X POWER SUPPLY

