

Codice: AV5489XIAA

CREATING LIGHTING PATTERNS THANKS TO ANGULAR CONNECTORS

- recessed, lighting profile - dedicated to medium-voltage light sources
- continuous line of light (when using LED strip 120 P/m and white cover)
- angled connections illuminated
- 19 accessories available
- 3 mounting options of LED modules: thermic tape, LED module on a strip, additionally LED clamp
- maximum LED source width: 20 mm

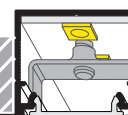

Codice: AV5489XIAA

- E** slide cover
- F** click cover
- E7** E7 click cover
- U7**¹ U7 mounting plate
- U7**² cone U7 mounting plate
- U7**³ rack U7 mounting plate
- U7**⁴ spring U7 mounting plate

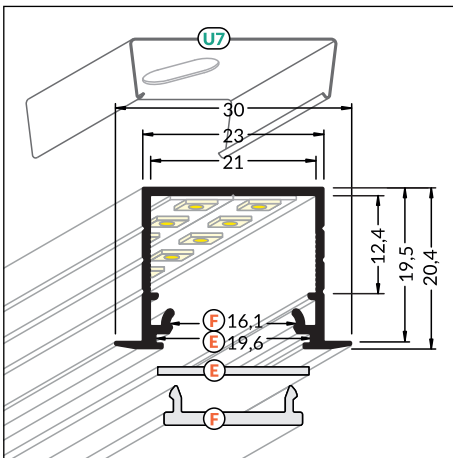
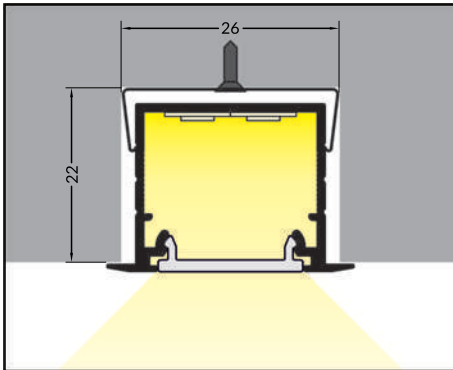
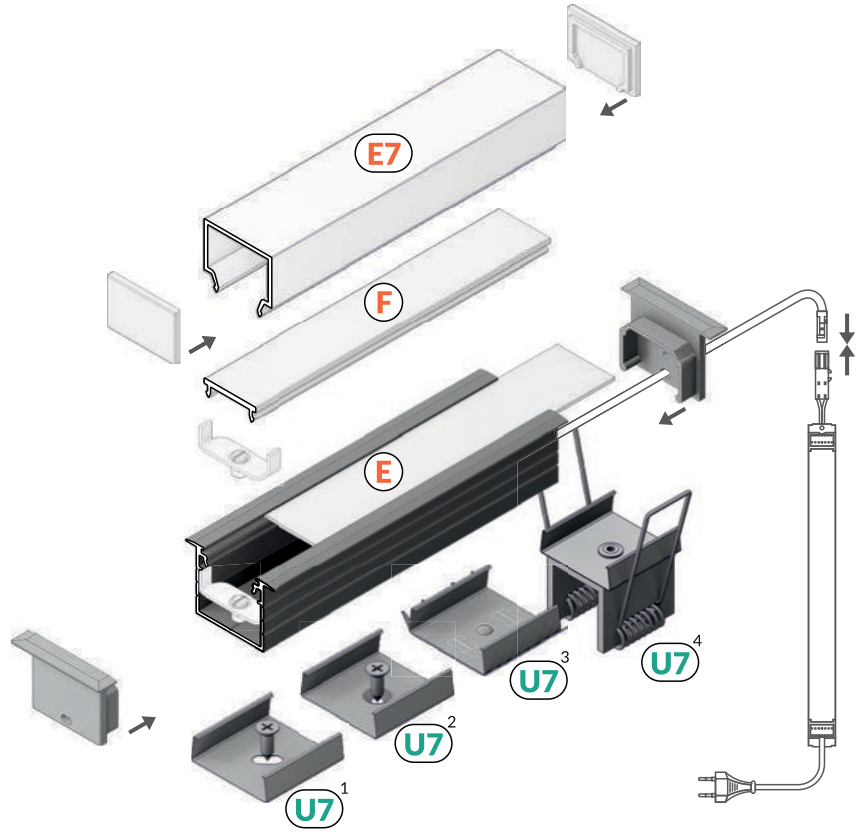

INDEX = 1 pc, length 2000 mm
package = 10 pcs

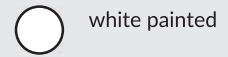

white painted



anodized



black anodized



raw aluminium

Available lengths
1000 mm, 2000 mm, 3000 mm, 4000 mm

ACCESSORIES

COVERS

E slide cover
 colours: transparent, frosted, white
 material: PC, PP, PP



Note! Dimensions of the space to install LED source

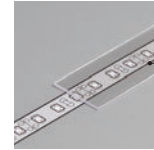
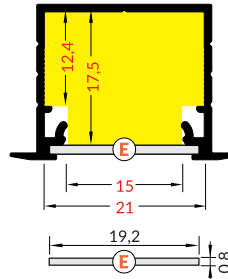

INDEX = 1 pc, length 2000 mm
 package = 10 pcs

E transparent

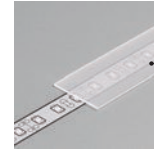

E frosted

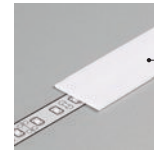

E white

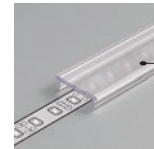

F transparent

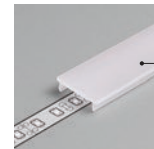

F white

F click cover
 colours: transparent, white
 material: PMMA

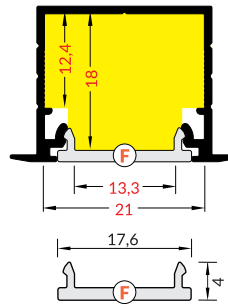

E7 click cover
 colour: white
 material: PMMA

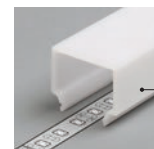
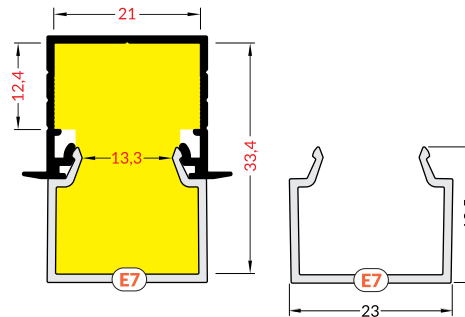

E7 white

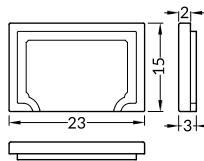

INDEX = 1 set
 package of 10 sets = 20 pcs



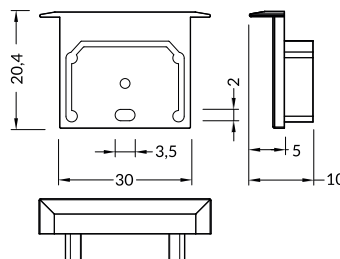

E7 white ending

ENDINGS

ending with hole
 colours: white, silver, black, grey
 material: ABS



INDEX = 1 set
 package of 10 sets = 20 pcs

-  white
-  silver
-  black
-  grey

ACCESSORIES

MOUNTINGS

U7 mounting plate
 colour: inox
 material: stainless steel

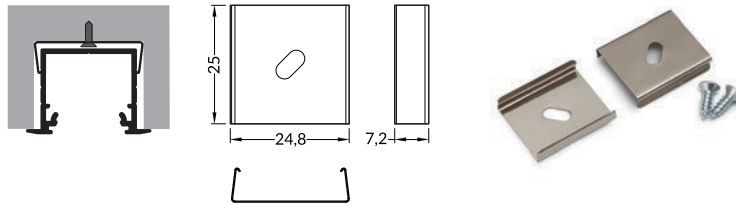

INDEX = 1 set
 package of 10 sets = 20 pcs

U7 mounting plate



cone U7 mounting plate
 colour: inox
 material: stainless steel

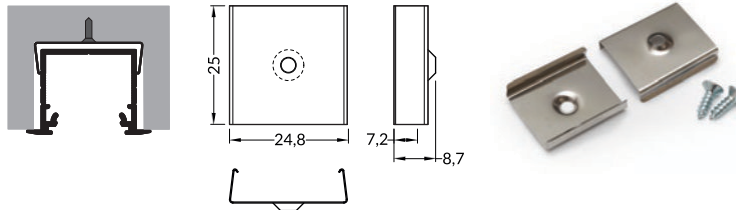

cone U7 mounting plate



rack U7 mounting plate
 colour: inox
 material: stainless steel

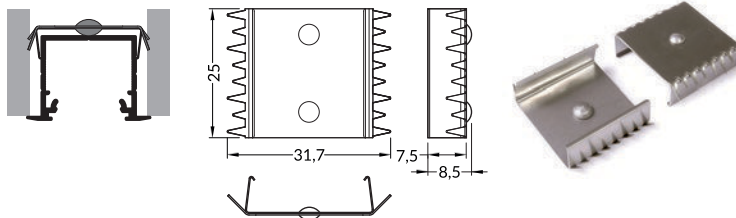

rack U7 mounting plate



spring U7 mounting plate
 colour: inox
 material: stainless steel

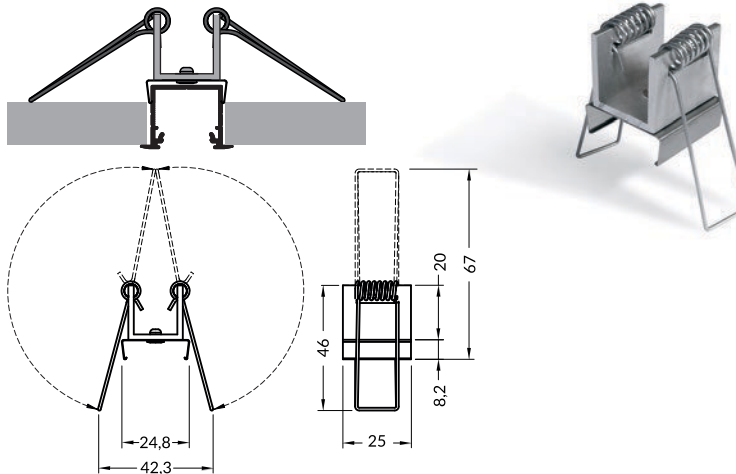

INDEX = 2 pcs

spring U7 mounting plate



CLAMP

clamp
 colour: white
 material: painted steel, plastic

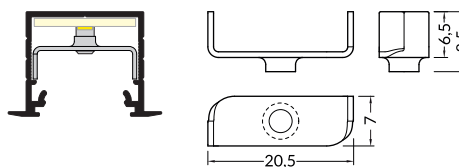

INDEX = 1 set
 package of 10 sets = 20 pcs



clamp
 colour: white
 material: painted steel, plastic

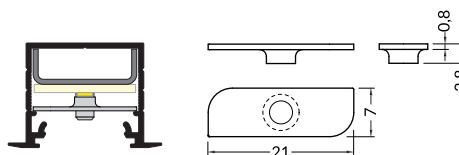

ACCESSORIES

CONNECTORS

connector 60 deg
 colours: white, anodized, black
 material: aluminium, polycarbonate

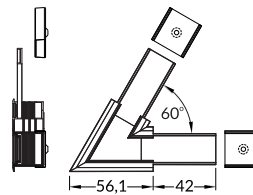

connector 90 deg
 colours: white, anodized, black
 material: aluminium, polycarbonate

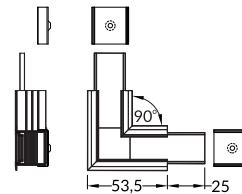

LINEA-IN20 connector 90 deg bent
 colours: white, anodized, black
 material: aluminium, polycarbonate

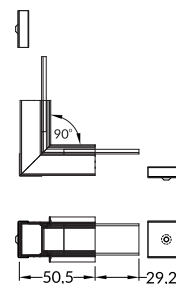

connector 120 deg
 colours: white, anodized, black
 material: aluminium, polycarbonate

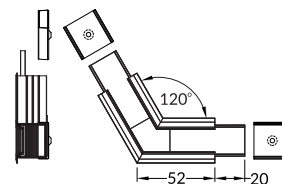

connector 135 deg
 colours: white, anodized, black
 material: aluminium, polycarbonate

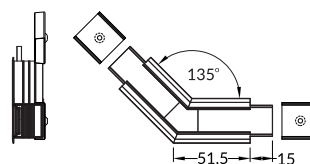

connector 180 deg
 material: polycarbonate

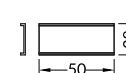

connector 270 deg bent
 colours: white, anodized, black
 material: aluminium, polycarbonate

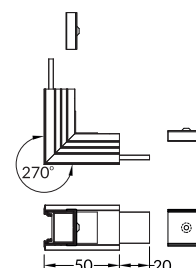

INDEX = 1 set

connector 60 deg

-  white
-  anodized
-  black

connector 90 deg

-  white
-  anodized
-  black

connector 90 deg bent

-  white
-  anodized
-  black

connector 120 deg



-  white
-  anodized
-  black

connector 135 deg

-  white
-  anodized
-  black

connector 180 deg

connector 270 deg bent

-  white **E4950001s**
-  anodized **E4950020s**
-  black **E4950021s**

CONNECTION POSSIBILITY



60°



90°

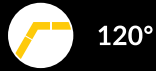

120°

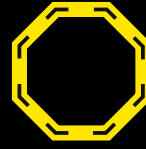

135°



180°

ANGULAR CONNECTORS

Thanks to five different angle connectors (60° / 90° / 120° / 135° / 180°) it is possible to create many various lighting systems - with no need to cut the profile at an angle.

Bent connectors allows to connect profiles in two planes, at two angles: 90° on the inside and 270° on the outside.

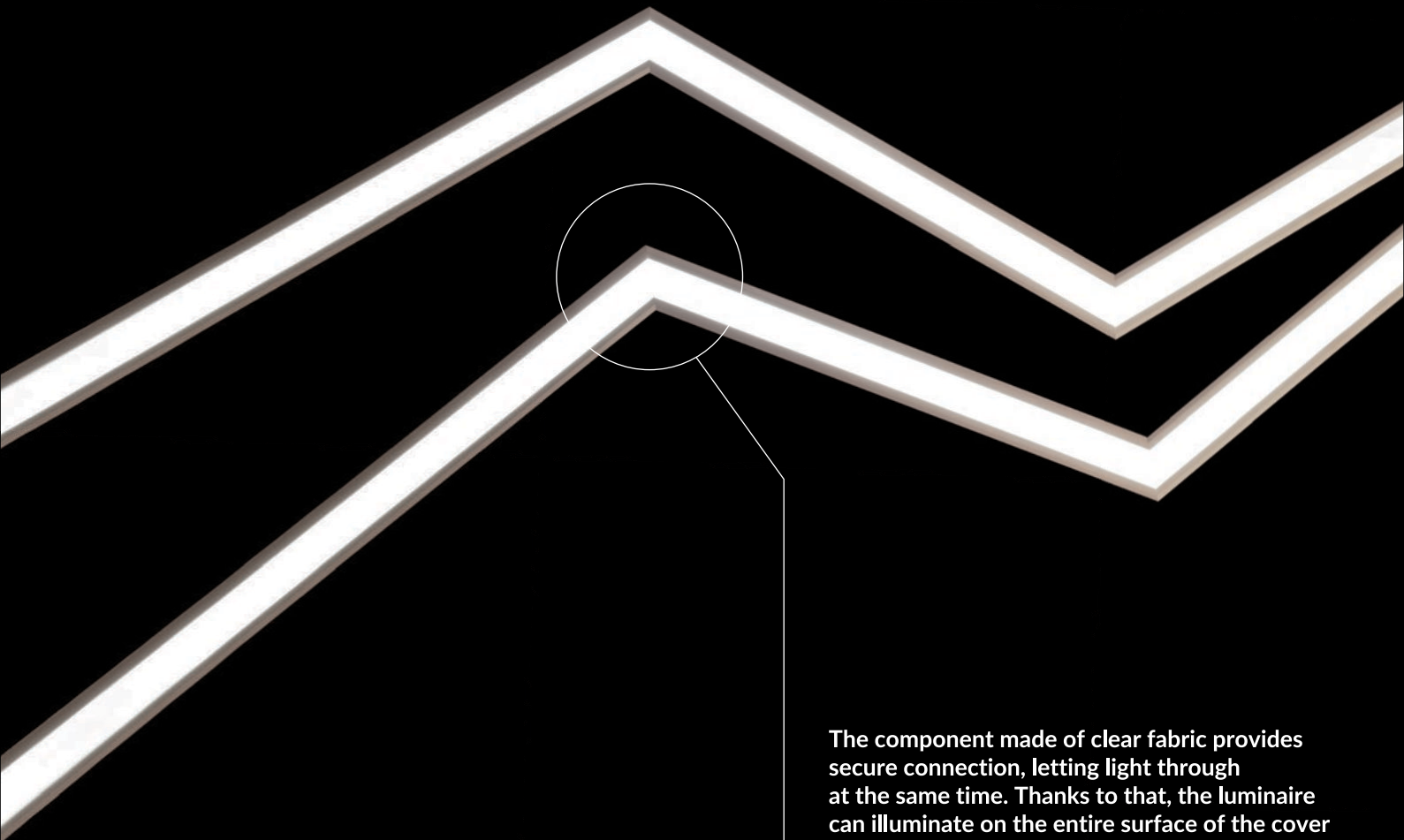

The component made of clear fabric provides secure connection, letting light through at the same time. Thanks to that, the luminaire can illuminate on the entire surface of the cover - even in the corners.

CONTINUOUS LIGHT OF LINE
when using LED strip 120 P/m and white cover



