

Technical Specs



EX1



F1

Codice: AV2981IN



Receiver

AV2981IN

Input Voltage:	12~48Vdc	Working Temp.:	-30°C~55°C
Output Voltage:	3~46Vdc	Dimensions:	L175xW44xH30(mm)
Output Current:	CC 350/700/1050mA×4CH	Package Size:	L178xW48xH33(mm)
Output Power:	1.05W~48.3W×4CH Max 193.2W	Weight(G.W.):	165g
Wireless Signal:	2.4GHz		

Note: Receiver is sold separately.



Product Size:

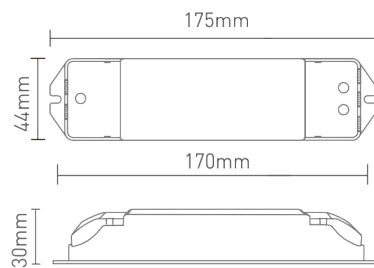
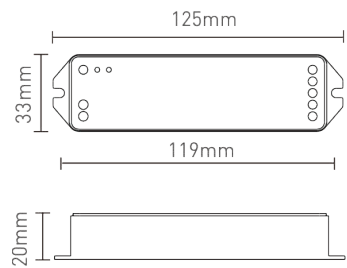

AV2981IN

Installation Instruction:

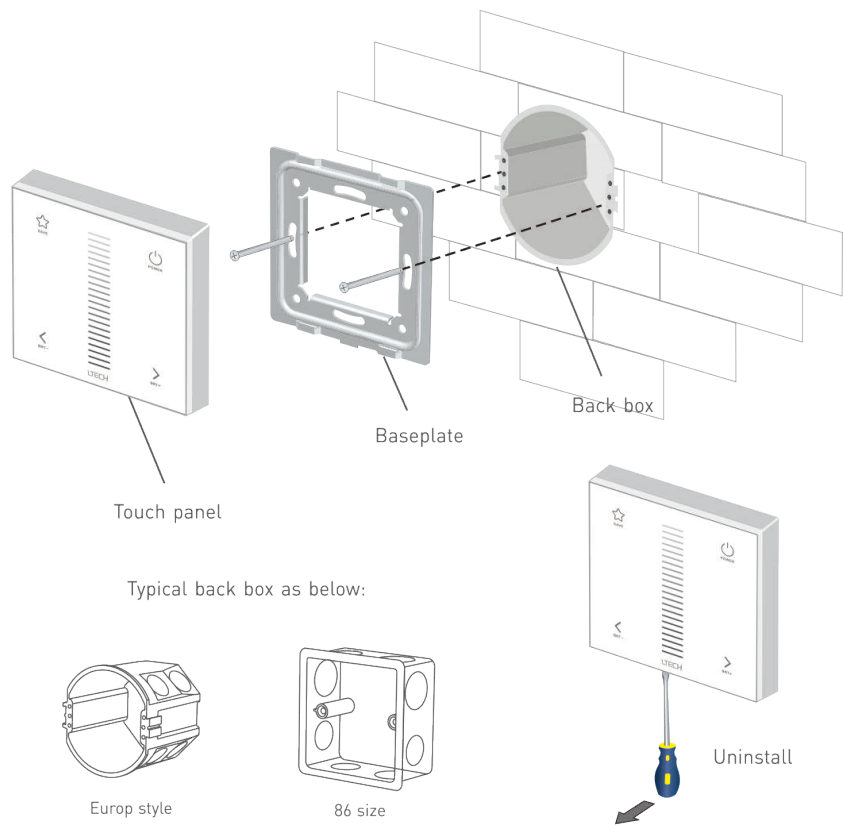

DMX Wiring:

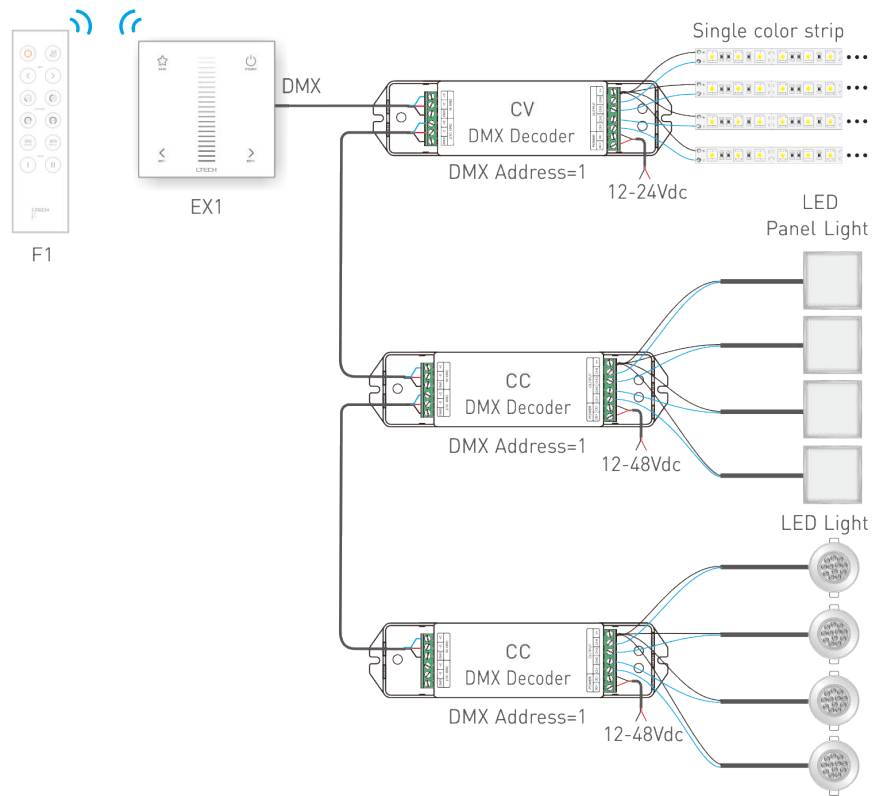

RF Wireless Wiring:

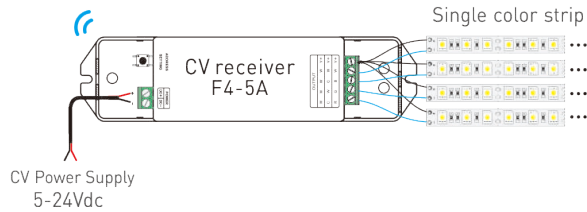
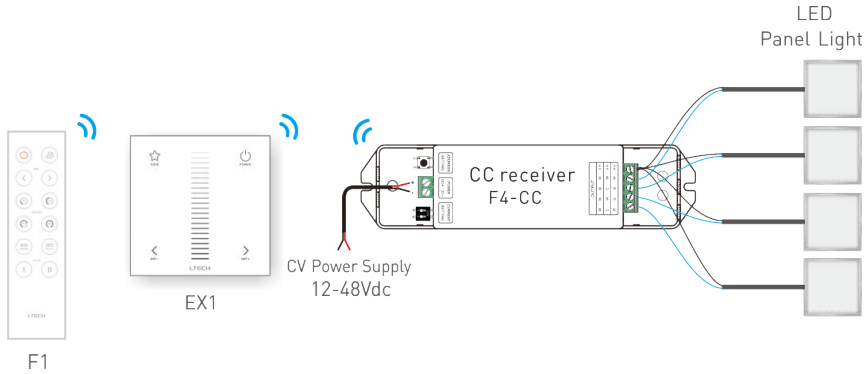

Multi-control Wiring:

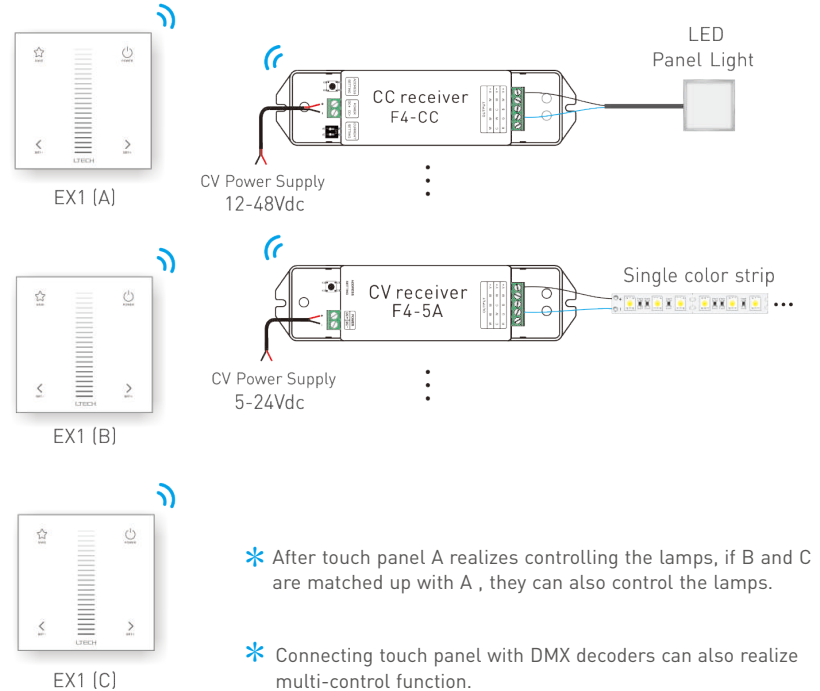

Match/Clear Code between Touch Panel & Receiver

Match code:

Method 1 : When the touch panel is on and the wiring between the receiver and the lamps are correctly,

1.



Receiver

Power on the receiver, and complete step 2 within 10s.

2.



Long press  on the touch panel, the lamps begin flicker.

3.



Touch the slider in 5s, the lamps stop flicking, match successfully.

Method 2 : When the touch panel is on and the wiring between the receiver and the lamps are correctly,

1.

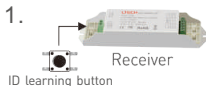

ID learning button

Short press "ID learning button" on the receiver.

2.



Long press  on the touch panel, the lamps begin flicker.

3.



Touch the slider in 5s, the lamps stop flicking, match successfully.

Clear code:

Method 1: Power on and off the receiver continuously for 5 times, If the buzzer long beep and lamps flicker twice, deactivate the matching successfully.



Receiver

Method 2: Long press "ID learning button" on receiver for 5 seconds, If the lamps flicker twice, deactivate the matching successfully.



ID learning button

Match/Clear Code between Remotes:

Match code:

1.



Assuming that B match up with A.

2.



Long press  on the B, the indicator lights of 4 keys keep on after release.



3.



Touch the slider on A in 5s, when the indicator lights of B turn off, match successfully.

Clear code:



Long press the two keys   on the touch panel B simultaneously (about 3 seconds) until the indicator light flicker several times, deactivate the matching successfully.

Match/Clear Code between Touch Panel & Remote:

Match code:

1.



Long press  on the touch panel, the indicator light of the four keys flicker.



2.



Long press  on the remote, the indicator light stop flicking, match successfully.

Clear code:



Long press the two keys   on the touch panel simultaneously (about 3 second), if the indicator light flicker 3 times, deactivate.