

DIMMER CON MANOPOLA - REGOLATORE DI POTENZA CON SGNALE DI USCITA 0-10V

0-10V Dimmer



FC CE RoHS

warranty
5 years



1. Technical Specs:

0-10V Dimmer	Codice: AV2646XIAA		
Input Voltage:	100~240Vac, 50-60Hz	Dimensions:	L86×W86×H50(mm)
Switching Power:	90~250Vac, 5A	Package Size:	L106×W106×H60(mm)
Output:	0~10V Max. 50mA	Weight(G.W.):	220g
Working Temp.:	-10°C~35°C		

2. Installation Instruction:

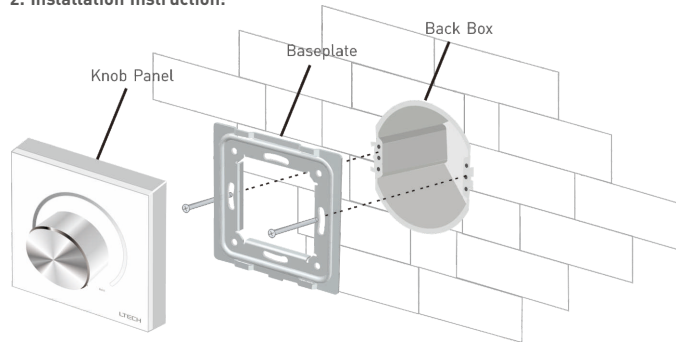

Typical back box as follow:

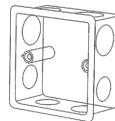
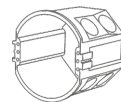

3. Product Size:

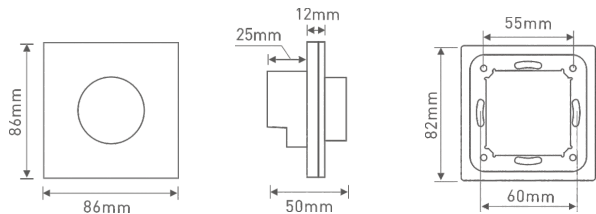

4. Knob Function:



5. Terminals:

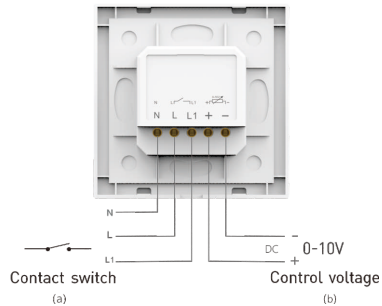

6. Wiring Diagram:

6.1 Dimming

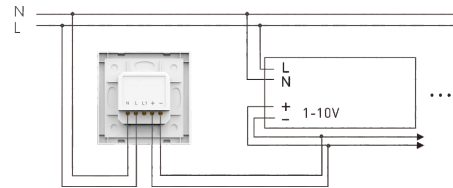

6.2 Built-in power switch

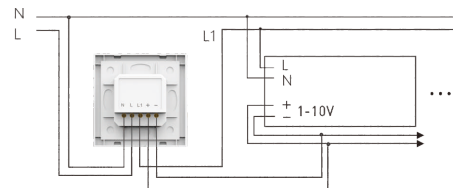

6.3 External relay connection

