



- 
 Protezione dai corpi solidi $\text{Ø}>1\text{ mm}$
Protection against solid objects $\text{Ø}>1\text{ mm}$
- 
 Class III
- 
 Applique a soffitto e a parete
Ceiling and wall applique
- 
 Possibilità di scelta tra diverse ottiche
Available in different optics
- 
 Cavo 50 cm in dotazione
50 cm cable included
- 
 Collegare in serie 350mA
Connect in series at 350mA
- 
 Dimmerabile su richiesta
Dimmable on request

Sistema lineare ad applique, in alluminio anodizzato, dalle performance eccellenti, compatto e dalle linee essenziali, disponibile in diverse lunghezze.

Ideale per l'installazione in gioiellerie dove mette in risalto diamanti e pietre preziose favorendone il brillio.

Adatto a diverse applicazioni architeturali, residenziali e ricettive.

Disponibile anche in versione bianco dinamico.





Applique linear light, in anodized aluminium, with excellent performances, compact and with essential lines, available in different lengths.

Ideal for installation in jewellery shops where it enhances diamonds and precious stones making them sparkle.

This device is also ideal for different architectural, residential and hospitality applications.

Also available in dynamic white.

COLOURS

- 
 Cool white
- 
 Natural white
- 
 Warm white 3000°K
- 
 Warm white 2700°K
- 
 Amber





WW NW W



A WW W

FINISHES

- White 
- Grey 
- Black 

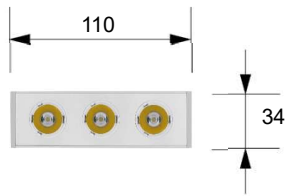
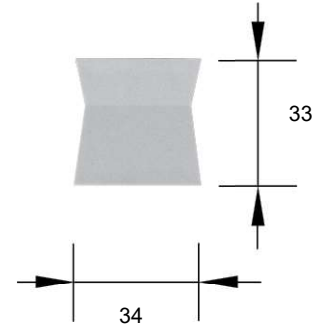

3 LED



180 gr



3-6W

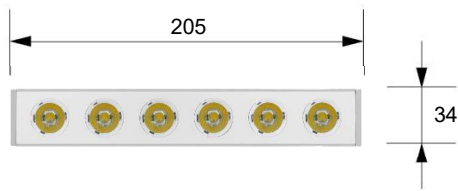

6 LED



320 gr



6-12W

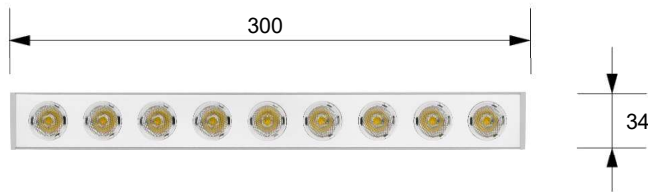

9 LED



460 gr



9-18W

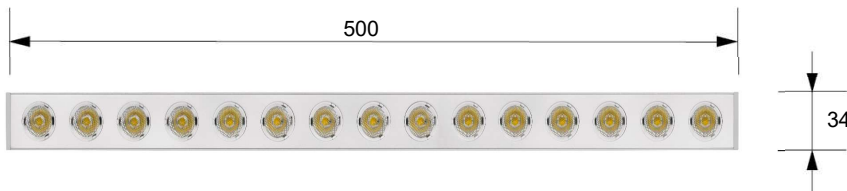

Code: AV02257GN

15 LED



750 gr



15-30W

OPTICS

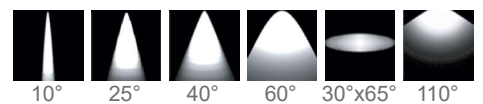

10°

25°

40°

60°

30°x65°

110°