

FLEX NEON 1010 FLAT 24V IP67

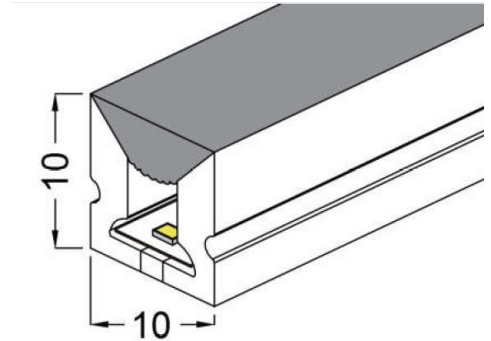

CODICE	PARAMETRI BASE						PARAMETRI FOTOMETRICI					
	Misure	Unità di Taglio	LED/mt	Input Volt	MacAdam ellipse	WaĖ	CRI	Colore Luce	Lumen nominali	Adesivo	Chip	IP
FLAT												
AV0151LU-E/1CUT	10000x10x10 mm	1cm	140	24VDC	3 Step	10W/mt	≥90	3000K	750LM/mt	3M VHB 5952	Epistar	IP67
AV0156LU-E/1CUT	15000x10x10 mm	1cm	140	24VDC	3 Step	10W/mt	≥80	3000K	750LM/mt	3M VHB 5952	Epistar	IP67
AV0184LU-E/1CUT	5000x10x10 mm	1cm	140	24VDC	3 Step	10W/mt	≥80	BLU	-	3M VHB 5952	Epistar	IP67

**Lunghezza Flex standard 5mt, lunghezza custom da 0,1 a 20mt.
Tipologia cavo: 2x0,5mm² - 20AWG wire.

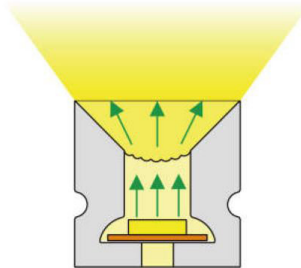
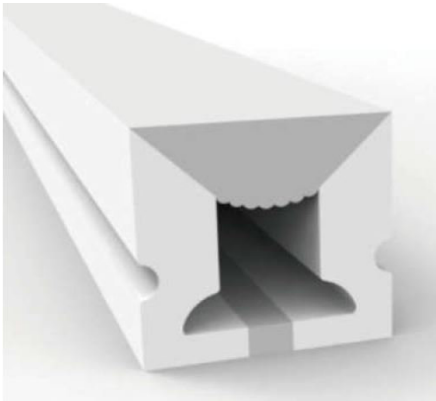
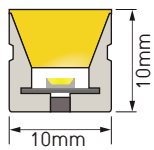
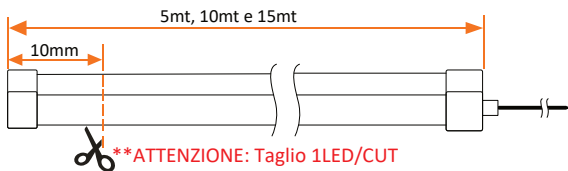

FLAT

TOP VIEW - FLESSIONE VERTICALE
R < 60 mm

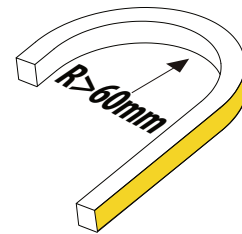

ACCESSORI:



Tappo con senza foro: AV0028LU-E
Tappo con foro: AV0029LU-E



Clip di fissaggio L.20mm: AV0042LU-E
Clip di fissaggio L.30mm: AV0159LU-E

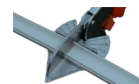

Forbici per flex: AV9999LU-E