

FLEX NEON 1010 FLAT & CONVEX 24V IP67

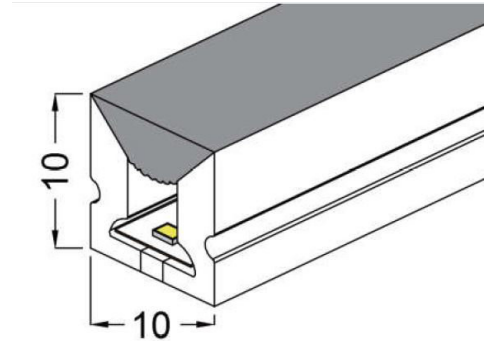

CODICE	PARAMETRI BASE						PARAMETRI FOTOMETRICI					
	Misure	Unità di Taglio	LED/mt	Input Volt	MacAdam ellipse	Watt	CRI	Colore Luce	Lumen nominali	Adesivo	Chip	IP
FLAT												
AV0151LU-E/1CUT	5000x10x10 mm	1cm	140	24VDC	3 Step	10W/mt	≥90	3000K	750LM/mt	3M VHB 5952	Epistar	IP67
AV0014LU-E	5000x10x10 mm	50mm	140	24VDC	3 Step	10W/mt	≥80	4000K	800LM/mt	3M VHB 5952	Epistar	IP67
AV0292LU-E	5000x10x10 mm	50mm	140	24VDC	3 Step	15W/mt	≥80	3000K	1125LM/mt	3M VHB 5952	Epistar	IP67
AV0155LU-E	5000x10x10 mm	50mm	140	24VDC	3 Step	15W/mt	≥80	4000K	1200LM/mt	3M VHB 5952	Epistar	IP67
CONVEX												
AV0015LU-E	5000x10x10 mm	50mm	140	24VDC	3 Step	10W/mt	≥80	3000K	750LM/mt	3M VHB 5952	Epistar	IP67
AV0016LU-E	5000x10x10 mm	50mm	140	24VDC	3 Step	10W/mt	≥80	4000K	800LM/mt	3M VHB 5952	Epistar	IP67

**Lunghezza Flex standar 5mt, lunghezza custom da 0,1 a 20mt.
Tipologia cavo: 2x0,5mm² - 20AWG wire.

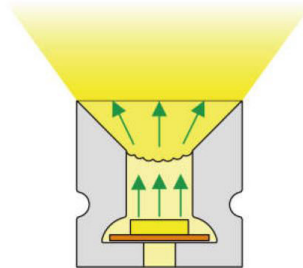
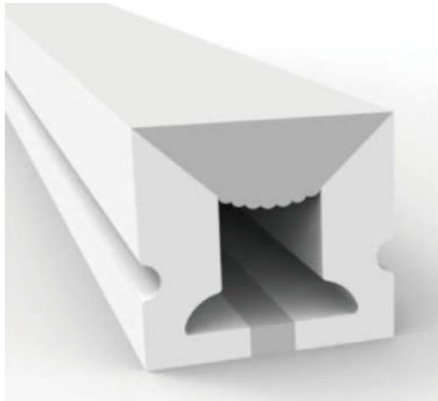
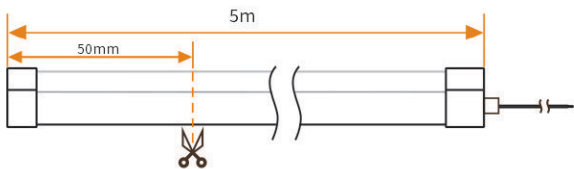

**ATTENZIONE: Il Flex neon cod. AV0151LU-E/1CUT si taglia ogni 10mm

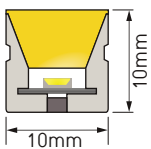

FLAT

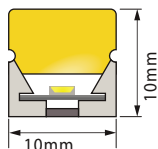

CONVEX

TOP VIEW - FLESSIONE VERTICALE
R < 60 mm

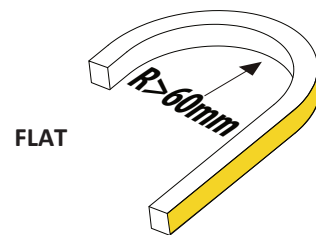

FLAT



CONVEX

ACCESSORI:



Tappo con senza foro: AV0028LU-E
Tappo con foro: AV0029LU-E



Clip di fissaggio L.20mm: AV0042LU-E
Clip di fissaggio L.30mm: AV0159LU-E

