



Code: AV01376GN

Totalmente protetto contro polvere e da immersione continua
Totally protected against dust and continuous immersion



Class III



Incasso a parete e a pavimento
Wall and floor recessed



Possibilità di scelta tra diverse ottiche
Available in different optics



5 mt cavo AD8 o H05RN-F in dotazione
5 mt AD8 or H05RN-F cable included



Collegare in serie 1W/350mA o 2W/500mA
Connect in series 1W/350mA or 2W/500mA



Controcassa per cemento e muratura
Outer case for concrete and brickwork



Profondità massima di immersione 3mt
Maximum depth of immersion 3mt



Totalmente in acciaio inox
Totally made in inox steel





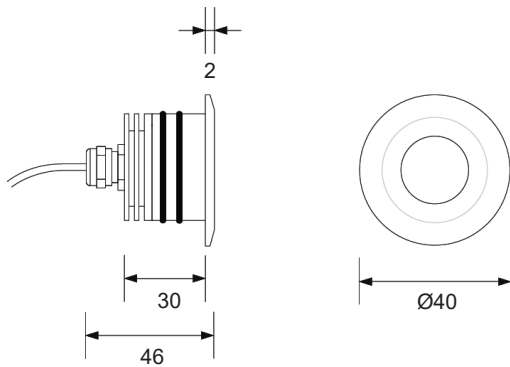





130 gr



Controcassa - Outer case



COLOURS

-  Cool white
-  Natural white
-  Warm white 3000°K
-  Warm white 2700°K
-  Amber
-  Red
-  Green
-  Blue

FINISHES

Inox AISI 316L 

OPTICS

