

Version: A1.2

Features

1. Ultra high cost performance
2. Adopt integrated lens
3. Single module can be cut
4. Support customization

Application

Suitable for 6-18cm depth light boxes, subways, supermarkets, bus stops, advertising letters, large shopping malls, etc.

Installation

Fix by adhesive tape or screws

Specification

Model No.	Light Color	Color Temperature(K)	Beam Angle	Typical Luminous Flux value(lm/pcs)	CRI	Efficacy (lm/W)	Voltage (V DC)	Power (W/pcs)
AV0114CBET-E	W	9000-12000	160°	81	80+	97	24	0.8
AV0113_BET-E	W	2900-3100	160°	114	80+	95	24	1.2
		3800-4300		118		98		
		4800-5300		120		100		
		6500-7000		120		100		
		9000-12000		118		98		

Other Parameters

Model No.	Quantity (LED Qty/pc)	Product Size L*W*H(mm)	Standard Run (pcs)	Max Run(single feed) (pcs)	Working Temperature	Storage Temperature
AV0114CBET-E	2	48*13*7.5	50	50	-20~+60°C	-20~+70°C
AV0113_BET-E	3	68*13*7.5	40	40		

NOTE:

1. Test environment temperature : 25±2°C.
2. Figures above are typical figures. Actual figures could be different with typical figures, and the data is subject to change without notice.
3. Different color temperature will make luminous flux different.
4. Power tolerance within ±10%.
5. The "Quantity"above means the LED quantity of single module

Profile Drawings

Unit:mm[inch]

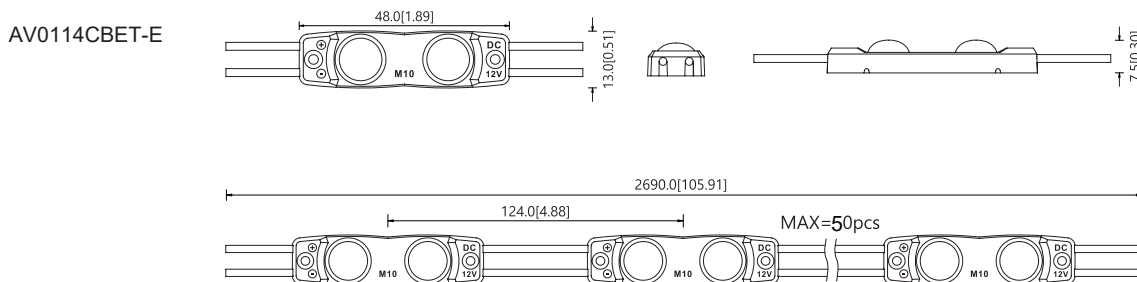

AV0113_BET-E

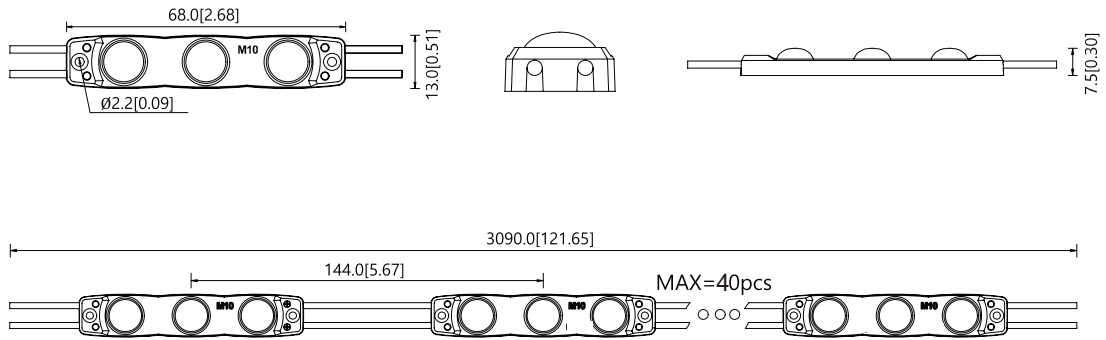

Note: For detail drawing, please consult sale rep.

Luminous Intensity Distribution Diagram

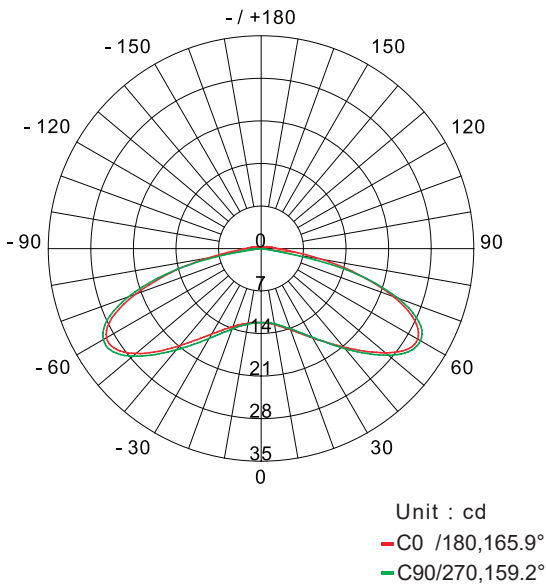

AVERAGE BEAM ANGLE(50%): 162.5°

Average Illumination

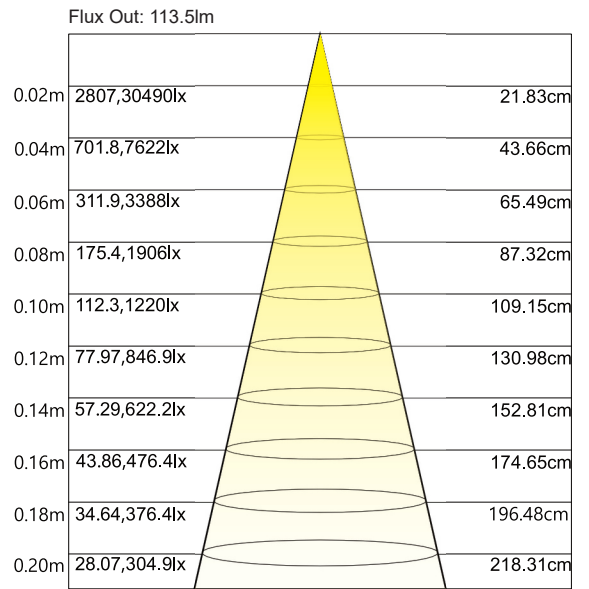

Height Eavg , Emax Beam Angle: 159.23° Diameter

Note: the above two figures are tested with the sample AV0113_BET-E, for other data, please consult sale rep.

Reliability Test

Type	Name	Standard	Condition	Result
Environmental test	PTC test	Blueview standard	TH=-40/60°C/15min each, TH=-40/60°C/45min each, a cycle every 2h, light on for 5min, light off for 5min	Pass
	High Temperature test		TH=60/80°C,continuous power on	
	Anti-UV test		TH=50°C,UVB:315~400nm	
	Room Temperature Aging test		Ta=25°C,continuous power on	
	Water-spray test		Water spray pressure 0.02MPa, volume 0.75m ³ /h, diameter, ∅ 6.3mm, lasts 3min	
	Waterproof performance test		The water spray pressure 0.02MPa, volume 0.75m ³ /h,diameter 6.3mm, and the water spray lasts for 3min.	
Other test	Flame Retardant test	Blueview standard	Placed the sample vertically in the needle flame tester, the flame lasted for 10s and then observe the self-extinguishing time of the sample.	Pass

packing

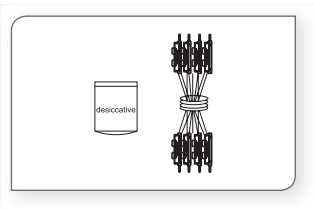

Prepare the desiccant and bind the product.

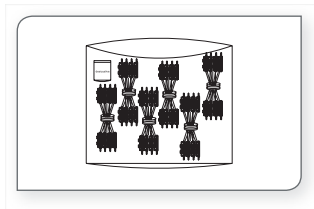

Put the product and desiccant into static shielding bag.

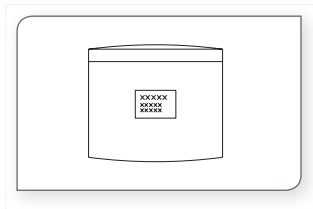

Seal and label the static shielding bag.

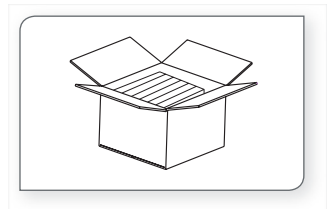

Put the static shielding bag side by side into carton box.

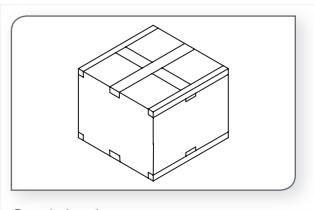

Seal the box.

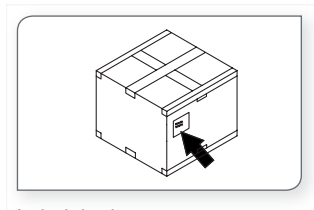

Label the box;

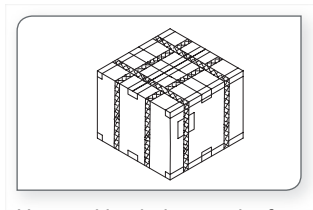

Use packing belt to pack after adding the edge protectors.

Packaging information

Model No.	Product Size L*W*H(mm)	Carton Size(mm)	PCS/Bag	Bag/Carton Box	Net Weight(kg)	Gross Weight(kg)
AV0114_BET-E	48*13*7.5	390*390*325	120	--	--	--
AV0113_BET-E	68*13*7.5	390*390*325	100	20	15.50(1±10%)	17.50(1±10%)

Note:the above quantity and weight are only for the illustrated packaging method. there will be differences in the quantity and weight with other packaging methods.

AV0113_BET-E (3 LED)

Installation

Connection Diagram

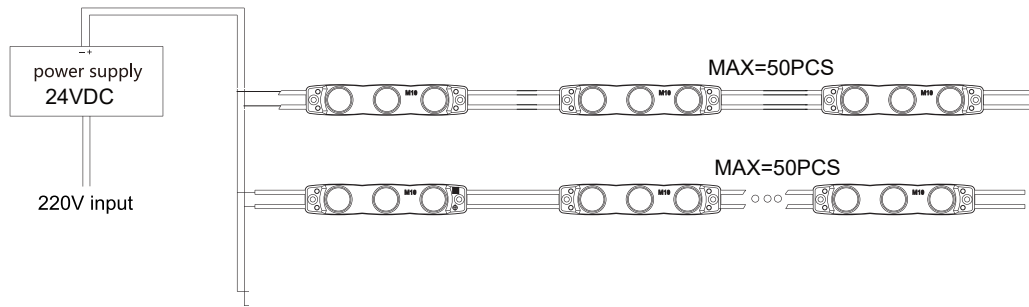

Irregular light box (Font logo, etc)

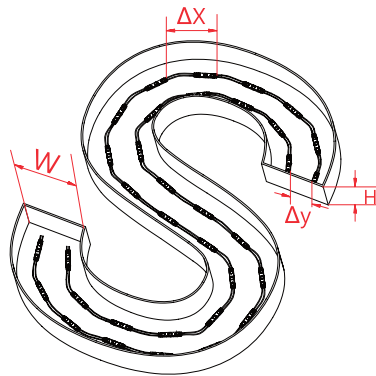

Test Data

Depth(H) cm	Illumination (lux)	Font width (W)	Spacing (Δ X)	Visual Effects
5	16000	6cm	9cm	OK
6	10000	6cm	11cm	
8	6500	11cm	15cm	
10	2860	17cm	15cm	
12.5	1180	34cm	15cm	

Depth(H) cm	Illumination (lux)	Font width (W)	Spacing (Δ X)	Spacing (Δ Y)	Visual Effects
5	/	/	/	/	OK
6	/	/	/	/	
8	14000	11cm	15cm	5cm	
10	6000	17cm	15cm	9cm	
12.5	2700	34cm	15cm	17cm	

Note:

The above data are obtained when AV0113_BET-E uses a white bottom material and a 3mm acrylic plate as the transparent material at the bottom of the lamp box; For illuminance data of other depths or illuminance data of other models, please contact the salesperson for requirements

The above figure is only a schematic diagram. Please refer to the real object for detail

AV0114_BET-E (2 LED)

Installation

Connection Diagram

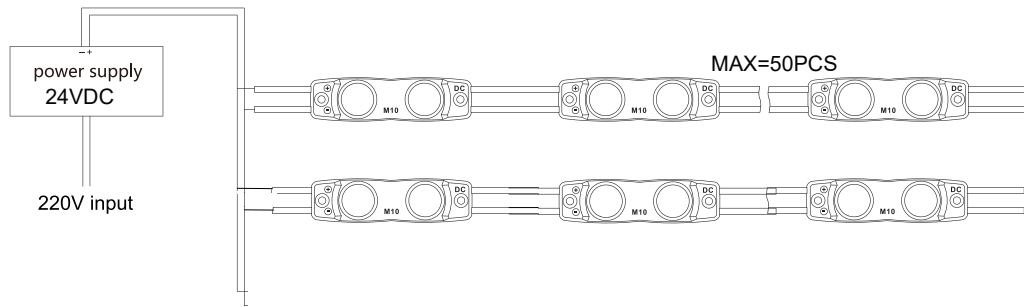

Irregular light box (Font logo, etc)

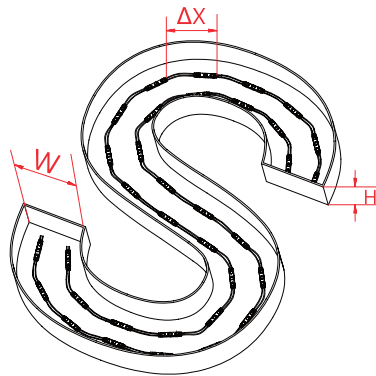

Test Data

Depth(H) cm	Illumination (lux)	Font width (W)	Spacing (Δ X)	Visual Effects
5	10800	6cm	9cm	OK
6	6800	6cm	11cm	
8	5600	11cm	12cm	
10	2430	17cm	12cm	
12.5	1000	34cm	12cm	

Depth(H) cm	Illumination (lux)	Font width (W)	Spacing (Δ X)	Visual Effects
5	/	/	/	OK
6	/	/	/	
8	12000	11cm	12*5cm	
10	5000	17cm	12*9cm	
12.5	2300	34cm	12*17cm	

Note:

The above data are obtained when AV0114_BET-E uses a white bottom material and a **3mm acrylic plate** as the transparent material at the bottom of the lamp box; For illuminance data of other depths or illuminance data of other models, please contact the salesperson for requirements

The above figure is only a schematic diagram. Please refer to the real object for detail

Regular light box

Model No	Surface Material	Depth(H) cm	Illumination (lux)	Evenness	Density (pcs/m ²)	Spacing (X*Y)	Power Density (W/m ²)	Visual Effects
AV0113_BET-E	White Soft Film	6	5970-7190	0.83	10*10	10*10	120	OK
		8	3840-4570	0.84	8*8	12*12	77	
		10	2770-3260	0.85	7*7	14*14	59	
		12	2450-2820	0.87	7*7	14*14	59	
		15	2050-2280	0.90	7*7	14*14	59	
		18	1668-1833	0.91	7*7	14*14	59	

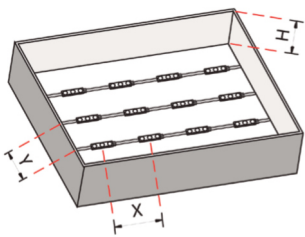

Note:

1. X indicates the horizontal center spacing between modules;
2. Y indicates the longitudinal center spacing between modules;
3. Single LED modules are arranged in a square, X=Y.
4. When the depth of lightbox H>18cm, use more products to satisfy Illumination demand.
5. Light Box Bottom is White
6. Please ask the sales for other data.

Accessories & Tools

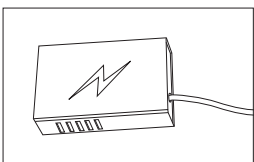

LED power supply

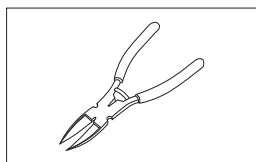

Diagonal pliers

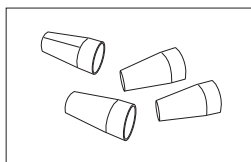

Connection terminal

Installation steps

Installation steps

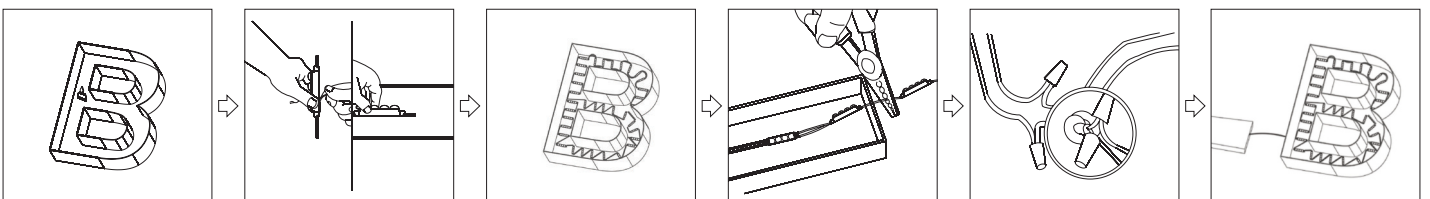

1. Clean the mounting surface.
2. Peel away the release paper on the back of led modules and stick them onto mounting surface.
3. Evenly arrange the led modules with appropriate space.
4. Cut the modules according to the requirements and treat the cut place with insulation and waterproof arrangement.
Note: Cut in the middle of the wire.
5. If the product needs to be connected, it is better to fix with connection ends.
Note: Treat the thread with insulation, waterproof, and anti-corrosion arrangement as it cannot pull out by hands.
6. Make sure the correct connection of positive and negative poles between led module and power supply.
Note: Treat the thread with insulation, waterproof, and anti-corrosion arrangement as it cannot pull out by hands.

Attentions before installation

- Before installation, check that the product parameters are consistent with the requirements (Seeing product specifications or product labels)
- Load voltage, current, power and power supply should be matched with the product.
- Follow the instructions of wiring diagram (first connect the load and then the power supply) to avoid short circuit.
- Make sure the correct connection of positive and negative poles between products and power supply. Otherwise, the light will not be on.
- Make sure the power cord firmly screwed into the terminal and it should not be pulled out by hands.
- The terminal should have insulation, waterproof and anti-corrosive treatment.
- After installing, the fabric light box must be covered with cloth within 48 hours and avoid long-term idle after installed.

Common Faults and Troubleshoot

Quick Guide		
Problems	Reasons	Solutions
All LEDs can not light on.	No electric supply.	Fix the short circuit problem.
	Automatic power protection from the open or short circuit in output of the power supply.	
	Wrong connection of power supply.	
LEDs can not light on partly.	Some switching mode power supplies are not powered.	Correctly connection.
	Power supply line error.	
	Mistaken wire connection of some of products	
Brightness of LED is inconsistent tor insufficient.	Power overloaded.	Replace with more powerful power.
	Power supply circuit excessive consumption.	Make sure the working voltage of the product within $\pm 5\%$ of standard voltage, or keep balance by circuit power consumption.
	Excessive quantities in series connection of the product	Reduce the quantities of the product in series connection to meet requirement.
LED flicker.	Connection point fault.	Remove bad connection point.
	Switching power supply failure.	Replace a new power supply.
	Wrong Installation or use of products	Please follow the instructions

Warning

- Do not disassemble or retrofit the light. Do not touch the surface of the light with a sharp object.
 - Do not do live-line working during installation, especially for high voltage product.
 - Do not use any organic chemical solvents.
 - Use neutral glass adhesive to fix this product and it needs to be dried 24 hours in the open environment after operation.
 - Treat the ends and the circuit connection points that are not connected to the main line with insulation, waterproof, and anti-corrosion in the installation.
 - Use 18AWG (0.75mm² cross-sectional area) or thicker core wire to avoid adverse consequences caused by overheating, if the power cable need to lengthen.
 - Make sure the input voltage meets the requirements and lines are connected correctly before lighting on.
 - This product is for signage, and do not use as general lighting.
 - Series connection within the max run.
 - The length of the power cable between the power supply and the led strip should not exceed 2 meters. Otherwise, large circuit loss will lead to inconsistent brightness.
 - Installation, maintenance and repair should be operated by a qualified technician.
-

Statements and Recycling

Statements:

- Repair should be operated by a qualified technician, if the external circuit or main line of this product is damaged.
- The parameters given in this manual are typical values and for reference only.
- All illustrations and drawings in this manual are for reference.
- This product is subject to change without notice.

Recycling:

- LED lighting products belongs to electronic products, please do recycling treatment according to the relevant WEEE directives.
-